

Power Lift & Recline Chair

OWNER'S MANUAL AND LIMITED LIFETIME WARRANTY



The Best Power Lift and Recline Chair Made in the USA 

 **GOLDEN**
technologies
YOUR LIFE IN MOTION

401 Bridge Street
Old Forge, PA 18518
www.goldentech.com



Dear Valued Customer,

Thank you for purchasing this Golden Technologies Power Lift and Recline Chair. Your Golden chair is tested and certified by NRTL Met Labs to UL and CSA electrical standards to assure that you have purchased one of the safest chairs available.

We believe that this product is made from the highest quality components available, is engineered to give you maximum service with minimum maintenance, and is backed up with the strongest warranty in the industry. We hope that you enjoy years of pleasurable use of your Golden Technologies chair and that this chair becomes a true assist to you in both sitting down and standing up.

Please take a few moments to review this manual to become familiar with the operation of this chair and our warranty. If you need additional information, please call the dealer from whom you purchased this chair.

Also, please note the following safety information: This power lift and recline chair is a medical device designed to help you sit down and stand up. Do not allow children to operate the chair at any time. When not in use, the chair should be kept in the sitting position.

Again, thank you for selecting this Golden chair.

Sincerely,

Robert Golden
Chairman and Founder



Complies with UL 73
and CSA C22.2 No. 68

Listing # E112417



IMPORTANT!















READ THIS MANUAL FIRST BEFORE INSTALLING OR OPERATING YOUR POWER LIFT AND RECLINE CHAIR.

Your power lift and recline chair has been engineered from the leg levelers up to provide the ultimate in strength and reliability.

Great care has been taken to provide you with total comfort and safety. Golden Technologies thoroughly inspects and tests each unit prior to shipment.

Your Golden power lift chair is a medical device. Therefore, you are required to exercise caution when operating it to ensure your personal safety and that of others around you. The following are rules for the safe operation of your Golden power lift chair.

WARNING

-  Care should be taken in the unpacking of this unit, so as not to cause injury to persons or damage to the unit. Dispose of all plastic bags and covers, as they can be a smothering hazard to small children.
-  Do not allow children or pets near the chair while the chair is operating.
-  Do not allow children to play with or operate the chair at any time.
-  Hand control should be unplugged and placed out of reach of children when the chair is not in use.
-  Do not flop down into the chair when getting into it, or while it is in its lift position. Flopping down into the chair will damage it and could cause personal injury.
-  Do not allow anyone to sit on your lap, or on the arm of the chair, or on the footrest while operating the chair, as it may cause tipping and could result in personal injury.
-  Do not place fingers or hands between the seat cushion and the inside arm of the chair while sitting in the chair or when the chair is in operation or plugged into a power source.
-  Do not retrieve fallen objects from inside or under the chair while the chair is plugged into a power source.
-  Do not operate chair if there are any persons, pets or other obstructions under or in front of the footrest, under the chair or behind the chair.
-  Do not smoke while operating, sitting or resting in the chair.
-  To reduce risk of electrical shock, do not immerse any of the electrical components into a liquid, or spill any liquids onto electrical components. Do not open any of the electrical components. There are no serviceable parts.
-  Warranty will be void if any of the electrical components are opened by other than a qualified service person.
-  Make sure the chair is placed at the specified distance from a wall/corner (page 4). Failure to do so can damage the chair and will void the warranty.
-  Do not use any type of electrical extension cord to plug your chair into an electrical outlet.

Installation Of Your Golden Power Lift Chair

Models: PR-200, PR-355M, PR-355L, PR-359M, PR-359L, PR-401, PR-410, PR-501JP, PR-501S, PR-501S-23, PR-501M, PR-501L, PR-501T, PR-643, PR-747, PR-751TY, PR-752, PR-906

1. Remove the transformer from the transformer box (located behind the lower outside back).
2. Plug the transformer into a 115-120V 60Hz A.C. outlet and connect the power cable from the chair into the transformer as shown. Power cable is located under the chair attached to the motor with white zip tie. Remove zip tie, extend the cable under and out behind the chair.

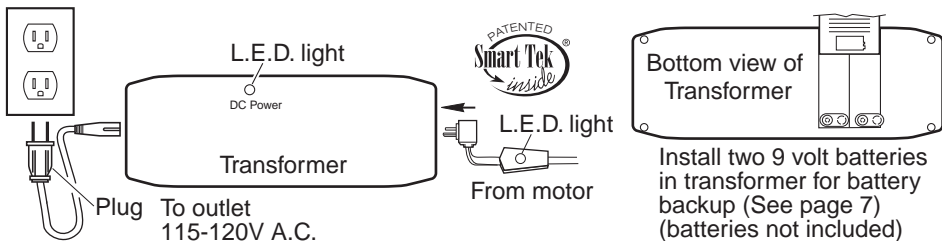

3. Place the chair in the desired position in the room, keeping it 17" away from the wall. If placing the chair into a corner, keep it 17" from the wall as shown. See distance chart below for your model.

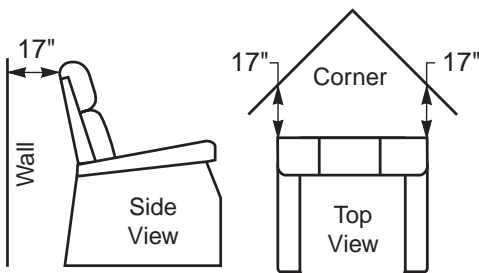

Distance Required From Wall When Reclined

Model Number	Wall	Corner
PR-200	11 in.	11 in.
PR-355M	17 in.	17 in.
PR-355L	18 in.	18 in.
PR-359M	17 in.	17 in.
PR-359L	18 in.	18 in.
PR-401	17 in.	17 in.
PR-410	19 in.	19 in.
PR-501JP	17 in.	17 in.
PR-501S	17 in.	17 in.
PR-501S-23	17 in.	17 in.
PR-501M	17 in.	17 in.

Model Number	Wall	Corner
PR-501L	18 in.	18 in.
PR-501T	19 in.	19 in.
PR-501M-26D	17 in.	17 in.
PR-501L-26D	18 in.	18 in.
PR-501T-28D	19 in.	19 in.
PR-643	18 in.	18 in.
PR-747	18 in.	18 in.
PR-751	18 in.	18 in.
PR-752	19 in.	19 in.
PR-906	6 in.	6 in.

4. Adjust the leg levelers on the bottom of the chair if necessary to level the chair. Some high pile carpets can obstruct the footrest operation by rubbing against it. Adjust the levelers to a height above the pile.
5. Slide the hand control from between the back and arm out toward the back of the chair. Secure the cord into the quick release cable clamp located above the magazine pocket on the arm of the chair.

Installation Of Your Golden Power Lift Chair

Models: PR-501M26, PR-501L26, PR-501T28

1. Install two 9 volt alkaline batteries in the inline battery holder as shown. The battery holder is zip tied (white) to the rear of the metal frame. Remove zip tie, extend the cable under and out behind the chair.

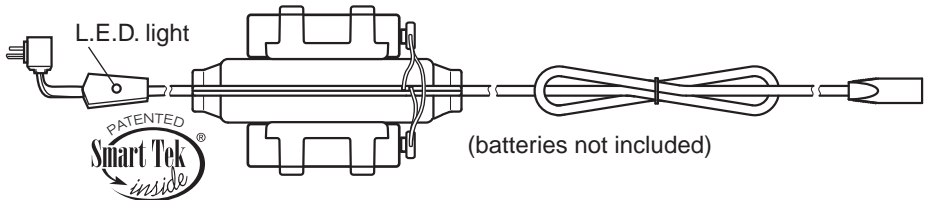

2. Remove the transformer from the transformer box, install two 9 volt batteries and plug the chair into a 115-120V 60Hz A.C. as shown in steps 1 and 2 on page 4.
3. Pull the hand control out of the magazine pocket and secure the cord into the quick release cable clamp located above the pocket on the arm of the chair.
4. Back installation: Press the down arrow on the hand control until the footrest is about parallel to the floor. This will expose the back brackets at the rear of the chair.
5. Slide the back down between the brackets until the threaded studs on the back slip thru the holes in the brackets as shown.
6. Thread the flange lock nuts onto the studs and tighten securely using the supplied wrench or a 7/16" box wrench. Return the chair to the seated upright position by pressing the up arrow on the hand control.
7. Attach the bottom of the outside back to the Velcro on the arm cross rail.

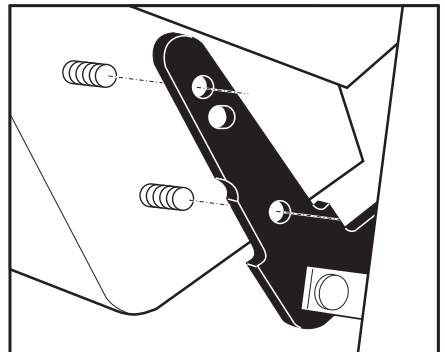
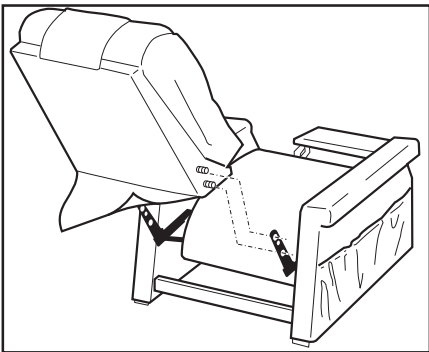

8. Place the chair in the desired position in the room, leaving the chair a safe distance from the wall. See distance chart on page 4 for the proper distance from the wall and corners.
9. Adjust the leg levelers on the bottom of the chair if necessary. Some high pile carpets can obstruct the footrest operation by rubbing against it. Adjust the levelers to a height above the pile.

Power Lift Chair Operation All Models

1. **To recline your chair**, press the down button (S2) and hold until you reach your desired position. Then release the button.
2. **To return to a seated position from recline**, press the up button (S1) and hold until the chair returns to a closed seated position. Then release the button.
3. **To lift your chair**, press the up button (S1) and hold until you reach your desired height. Then release the button.
4. **To return to a seated position from lift**, press the down button (S2) and hold until the chair returns to the floor seated position. Then release the button.
5. **To lift your chair from a reclined position**, press the up button (S1) and hold. The chair will keep going past the seated position and start to lift. Release the button when the chair reaches the desired height.
6. **To recline your chair from the lift position**, press the down button (S2) and hold. The chair will keep going past the seated position and start to recline. Release the button when the chair reaches the desired reclined position.
7. **Getting into your lift chair.** While standing next to your chair, press the chair up button (S1) and raise the chair to a height you can sit against. This height will vary from person to person depending on the individual's needs. Raise the chair high enough so you do not have to flop down into the chair. **Flopping down into the chair will damage it and could cause personal injury.** Press the chair down button (S2). As the chair continues downward, adjust yourself into a position that is comfortable to you. Continue pressing the button until chair is in the seated position (chair firmly on the floor), then release the button.
8. **Getting out of your chair**, press the chair up button (S1) and raise the chair to a height that enables you to easily stand. Release the button. Return the chair to the seated position (chair firmly on the floor) after getting out of the chair so children, pets or obstructions do not get under the chair.

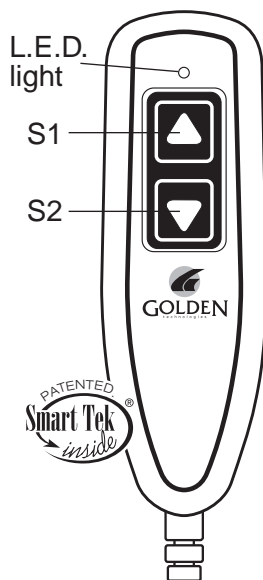

Note: Your Golden power lift chair can be stopped at any time during lift or recline by releasing the selected button, offering you a wide range of comfortable positions. Select the position that best suits your needs. The motor is set to shut off when it reaches its fully extended or fully retracted position if the selected button is not released. If you should go past your desired position, select the button to bring you back to your desired position. You can repeat the process as often as you like.

Battery Back Up System

Your Golden power lift chair comes with a battery back up system so the chair can return to the seated position in the event of a household power failure. The batteries have enough energy to bring the chair to a seated position from either recline or lift. The batteries do not have enough energy nor are they intended to operate the chair for a prolonged period of time in the absence of standard household voltage (120 volt, 60 Hz). Batteries should be replaced after one use. Batteries should be changed yearly. (See installation page 4 and 5.)

Smart Tek™ (Power Indication)

Regular servicing is not necessary on your Golden power lift chair. Your power lift chair is equipped with an indicator light on the hand control. This light illuminates green when any button on the hand control is pressed, indicating power to the hand control.

Your power lift chair also comes with a power indicator light on the transformer and on the power cord connecting the motor to the transformer. The lights illuminate green constantly, indicating power from the outlet to the transformer and the motor. The lights have been provided to help you identify electrical disconnects, should they occur, and to help your dealer to diagnose electrical problems, should they occur.

Should the chair not operate and the lights are out, check all electrical connections to the chair. Make sure everything is plugged in properly and there is power to the outlet into which the chair is plugged (see installation on page 4 and 5 for electrical connections). Should you ever encounter a problem with the operation of your power lift chair and the lights are on, such as mechanical problems or one light is out, discontinue all use of the product upon discovery of the problem. Contact the dealer from whom you purchased your chair. They will be able to resolve problems and take care of proper factory service if needed. You will need to be prepared to answer some basic questions about your power lift chair, such as model and serial number. The model and serial number are located on the back of the hand control and the rear of the lift frame. Your dealer will ask you questions about your power indicator lights, such as which one is out. Prior to calling your dealer, check all the electrical connections to the chair. Make sure everything is plugged in properly and there is power to the outlet into which the chair is plugged (see installation on page 4 and 5 for electrical connections).



CONSUMER LIMITED LIFETIME AND SEVEN YEAR WARRANTY

GOLDEN, through its authorized distributor/service organization, warrants this chair to original consumer only, against defects in material or workmanship as follows:

LIFT MECHANISM, RECLINE MECHANISM AND CHAIR FRAME LIMITED WARRANTY

GOLDEN, warrants for the lifetime of the chair by the original consumer to repair or replace at Golden's option the Lift Mechanism, Chair Frame and Recline Mechanism. Labor to replace these parts is subsidized on all models for three years. The Capri, Monarch and Monarch Plus are limited to six months subsidized labor. The Space Saver is limited to one year, parts and subsidized labor on the lift frame, recline mechanism and wood frame.

GOLDEN, shall not be responsible or obligated to pay for any cost or expense for examination of any warranted parts nor is Golden to pay for costs for transportation, handling and packaging of the parts or components.

THREE YEAR ELECTRICAL PARTS WARRANTY

GOLDEN, warrants the electrical parts of this chair against defects to original consumer only, for a period of three years from the date of original purchase by a consumer. The Monarch chair has electrical parts warranty of 2 years. The Capri and Space Saver chairs are limited to 1 year electrical parts warranty. Labor to replace these parts is subsidized for one year on all models except Capri, Monarch and Monarch Plus, which are limited to 6 months.

GOLDEN, shall not be responsible or obligated to pay for any costs or expenses for examination of any warranted parts nor is Golden to pay cost for transportation, handling and packaging of the parts or components.

ELECTRICAL PARTS LIMITED WARRANTY FOURTH THROUGH SEVENTH YEAR

During the period beginning with the expiration of the full three year parts warranty offered above and continuing through the seventh year after date of original purchase by a consumer, GOLDEN will warrant the electrical parts on the following pro-rated basis. Year 4 earns a 35% discount off suggested retail price. Year 5 earns a 25% discount. Year 6 a 15% discount and year 7 a 5% discount. By way of example, a part costing \$100.00 that needs replacement in year 4 would cost \$65.00. GOLDEN shall not be responsible or obligated to pay for any costs or expenses for examination and/or service of any warranted part or to pay for costs of transportation, handling and packaging of the chairs and/or parts or components. Capri, Monarch, Monarch Plus and Space Saver are excluded from this portion of the warranty.

TERMS APPLICABLE TO WARRANTIES

GOLDEN will, at its option, repair and/or replace the defective parts and/or components provided that the warranty parts have not been subjected to misuse, abuse or improper service by the consumer, have not been damaged in transit or handling and/or have not been altered or repaired by unauthorized representatives. This warranty does not include costs for unnecessary service calls, i.e., in-home service calls solely for the purpose of educating the consumer about the product, or finding an unsatisfactory power connection, etc. Exceeding the weight capacity of the chair will void the warranty.

Jr. Petite & Small Models	300 lbs.	Capri.....	325 lbs.
Medium, Large & Tall Models.....	375 lbs.	Royal, Regal, Williamsburg.....	375 lbs.
Dual Motor 26" & 28" Wide Models.....	500 lbs.	Cambridge, Winston, Pioneer.....	375 lbs.
Space Saver.....	250 lbs.		

In the event that the product does not conform to this warranty at any time while this warranty is in effect, Golden will correct the defect in conformity with the Consumer Limited Lifetime and Seven Year Warranty. THE LIMITED LIFETIME AND SEVEN YEAR WARRANTY SET FORTH ABOVE IS THE SOLE AND ENTIRE WARRANTY PERTAINING TO THE PRODUCT AND IS IN LIEU OF AND EXCLUDES ALL OTHER WARRANTIES OF ANY NATURE WHATSOEVER, WHETHER EXPRESS, IMPLIED, OR ARISING BY OPERATION OF LAW INCLUDING, BUT NOT LIMITED TO ANY IMPLIED WARRANTIES OF MERCHANTABILITY OR FITNESS FOR A PARTICULAR PURPOSE. THIS WARRANTY DOES NOT COVER OR PROVIDE FOR THE REIMBURSEMENT OR PAYMENT OF INCIDENTAL OR CONSEQUENTIAL DAMAGES.

Some states do not allow this exclusion or limitation of incidental or consequential damages so the above limitation or exclusion may not apply to you.

GOLDEN shall not be liable for any incidental or consequential damages or for any other damage or loss not contained in this warranty.

This warranty gives you specific legal rights, and you may also have other rights which may vary from state to state.

All warranty claims must be approved by Golden Technologies before any service is performed.

Warranty is valid in all 50 states, Canadian Provinces and Puerto Rico.

GOLDEN LIFETIME LIMITED WARRANTY

Register your GOLDEN POWER LIFT CHAIR by filling out this warranty card within 30 days of purchase date and returning to GOLDEN TECHNOLOGIES. Be sure to keep copies of this registration so you have all the information to refer back in case you experience a problem with your chair.

Name _____

Address _____

City _____ State _____ Zip _____

Purchase Date _____

Model No. & Size _____

Serial Number _____

Dealer's Name _____

Address _____

Why Did You Choose The Golden Power Lift Chair?

Appearance Price Dealer Reputation

Additional Comments _____

Remember to read your owner's manual carefully before you operate your chair. If you need help or additional information please contact your dealer.





GOLDEN TECHNOLOGIES
401 BRIDGE ST
OLD FORGE PA 18518-2323



PLACE
STAMP
HERE



Inquire about these fine mobility products also available from Golden Technologies



Try our full-time luxury scooter! Our Companion features our patented adjustable tiller, complete self-diagnostics, bright head/tail lights and a very comfortable seat with a weight capacity of 350 lbs!



Looking for a compact portable scooter? Our Buzzaround Lite is our smallest scooter offering a 250 lb. weight capacity. The Buzzaround Lite comes with three sets of shrouds in Red, Blue and Sahara.



The Golden Compass power chair is the ideal consumer power base. Featuring easy-to-use center wheel drive and many seating options, the Compass is in a class by itself!



Are you having trouble sleeping? Sleep better in the Golden luxury adjustable bed featuring multiple head and foot positioning with the option of a massage upgrade! No more tossing and turning in the Golden Luxury Adjustable Bed!
Not intended to be used as a medical device.

 **GOLDEN**
technologies
YOUR LIFE IN MOTION

FOR YOUR RECORDS

Please fill in your Power Lift & Recline Chair information below. This information will be useful in the event that you should ever need to contact Golden Technologies, Inc. concerning your lift chair.

Date of Purchase _____

Model _____

Serial Number _____

Your Golden Technologies, Inc. representative or dealer

Name _____

Company _____

Address _____



CAUTION



Do not allow children to play on this mechanized furniture or operate the mechanism.

Leg rest folds down on closing so that a child could possibly be injured.

Always leave chair in a sitting position. Keep hands and feet clear of mechanism. Only the occupant should operate it.



YOUR LIFE IN MOTION